

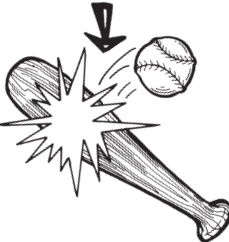

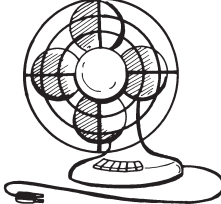
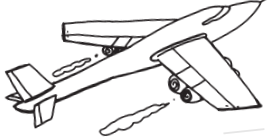
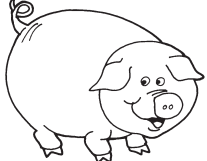

# Pretest/Posttest A

**To the Teacher:** Direct the child to cut out the word families along the dashed lines below. Then, have the child name each picture and glue the correct word family in the large box to finish the word. For additional testing after completing the activity, have the child tell you a word that rhymes with each picture.

 <b>b</b> <input data-bbox="500 436 787 646" type="text"/>	 <b>h</b> <input data-bbox="1172 436 1459 646" type="text"/>
 <b>f</b> <input data-bbox="500 709 787 919" type="text"/>	 <b>j</b> <input data-bbox="1172 709 1459 919" type="text"/>
 <b>p</b> <input data-bbox="500 991 787 1201" type="text"/>	 <b>d</b> <input data-bbox="1172 991 1459 1201" type="text"/>
 <b>c</b> <input data-bbox="500 1264 787 1474" type="text"/>	 <b>f</b> <input data-bbox="1172 1264 1459 1474" type="text"/>



an

at

et

ig

it

ot

ox

ug

# The *-an* Word Family

**Directions:** Circle each picture whose name rhymes with **man**.

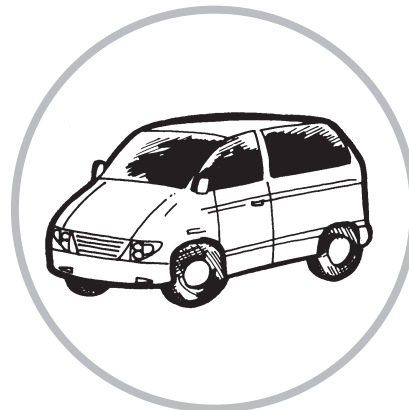
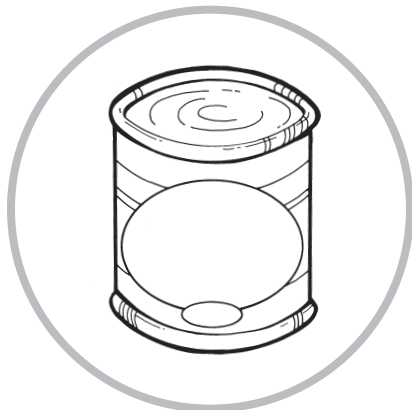
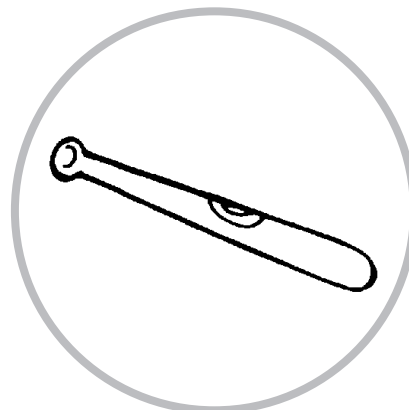
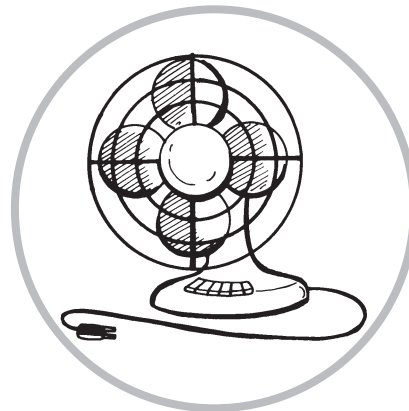
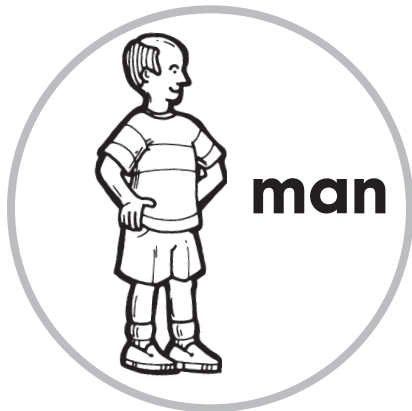

**Something to Try!** Write three words that rhyme with **man**.

\_\_\_\_\_

-----

can

\_\_\_\_\_

\_\_\_\_\_

-----

\_\_\_\_\_

\_\_\_\_\_

\_\_\_\_\_

-----

\_\_\_\_\_

\_\_\_\_\_

# More Short "a" Word Families

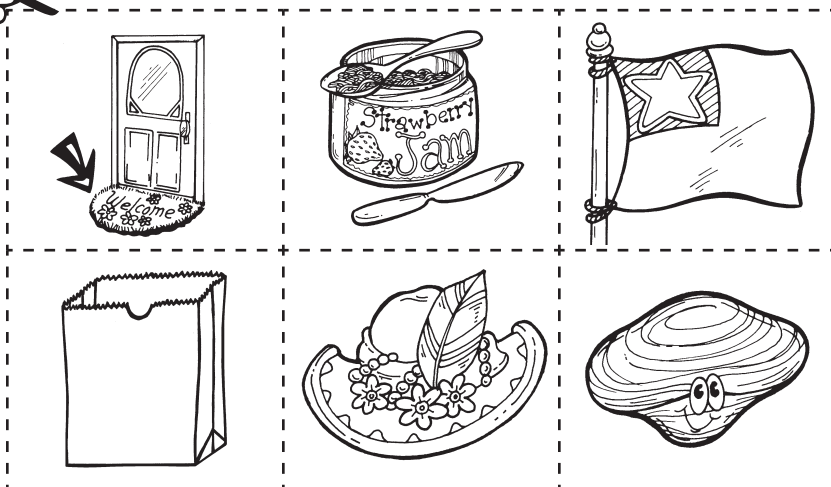
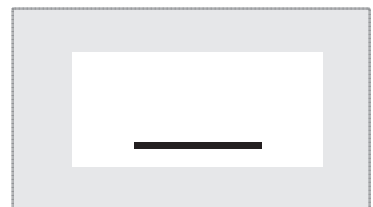
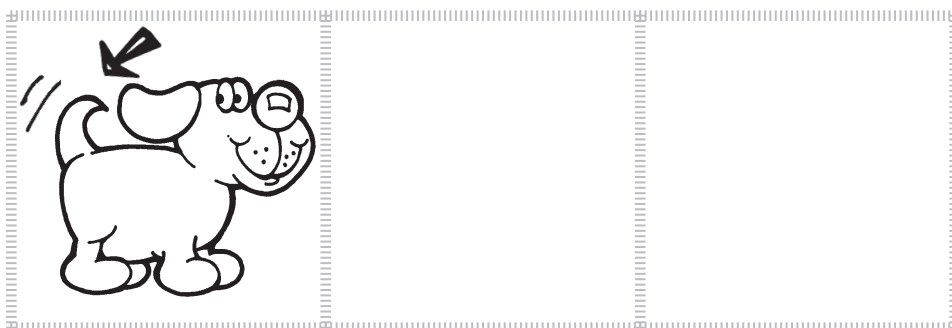
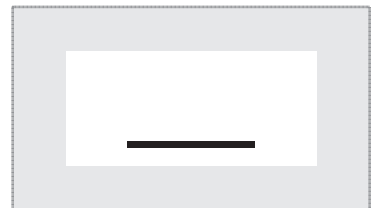
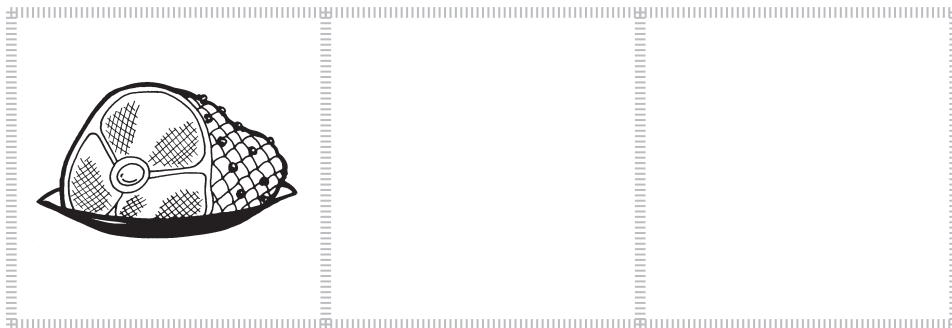

**Directions:** Cut out the pictures below. Glue the pictures that rhyme in the same row. Write the letter for the sound at the **end** of the words.



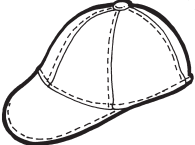

# Write *-an*, *-ap*, and *-at* Words



**Directions:** Name each picture. Write the word in the boxes.

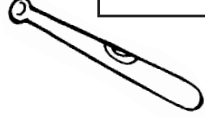

1.    
★ m  
★ a

2.    
★  
★ a

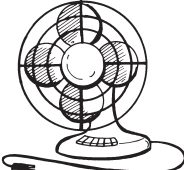
3.    
★  
★ a

4.    
★  
★ a

5.    
★  
★ a

6.    
★  
★ a